

# Kit - 4 =

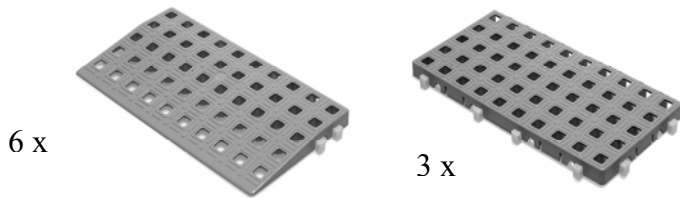

13 x  
R-Lock



13 x  
T-Lock

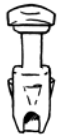

4 x



2 x



13 x

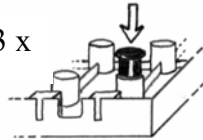

2 x

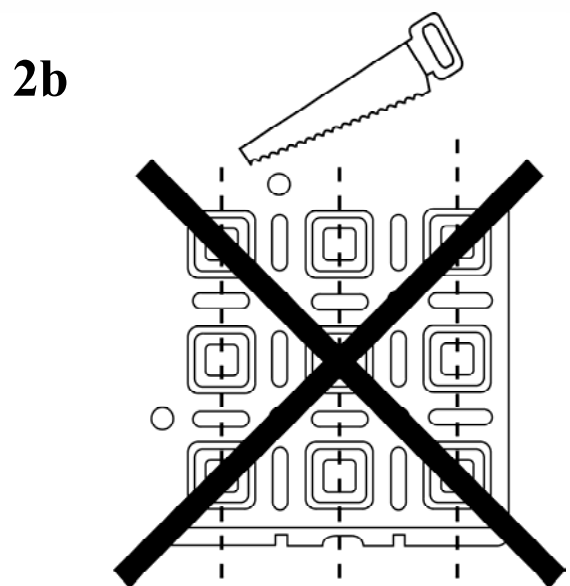
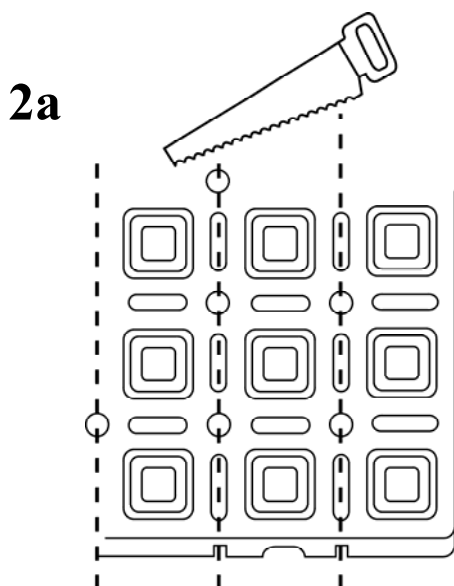
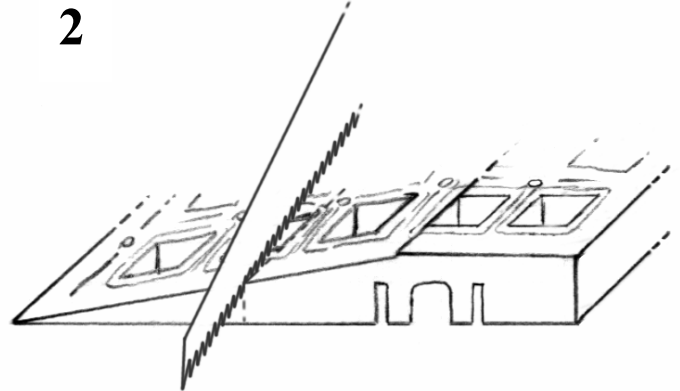
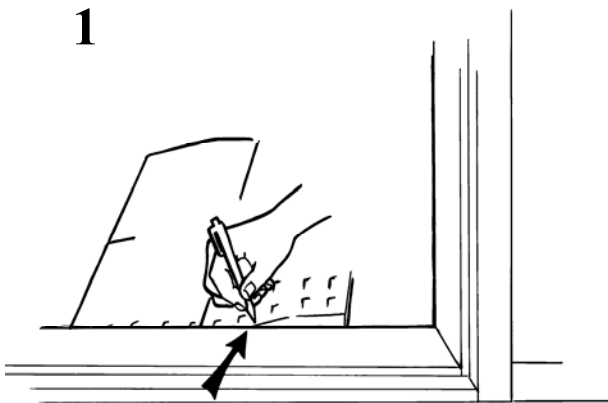

3

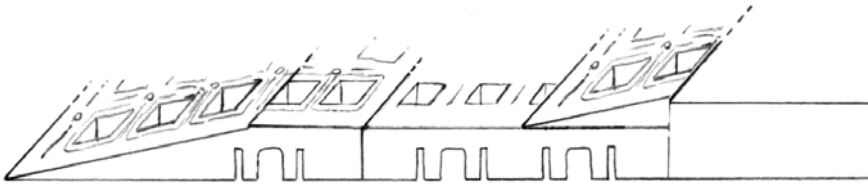

4

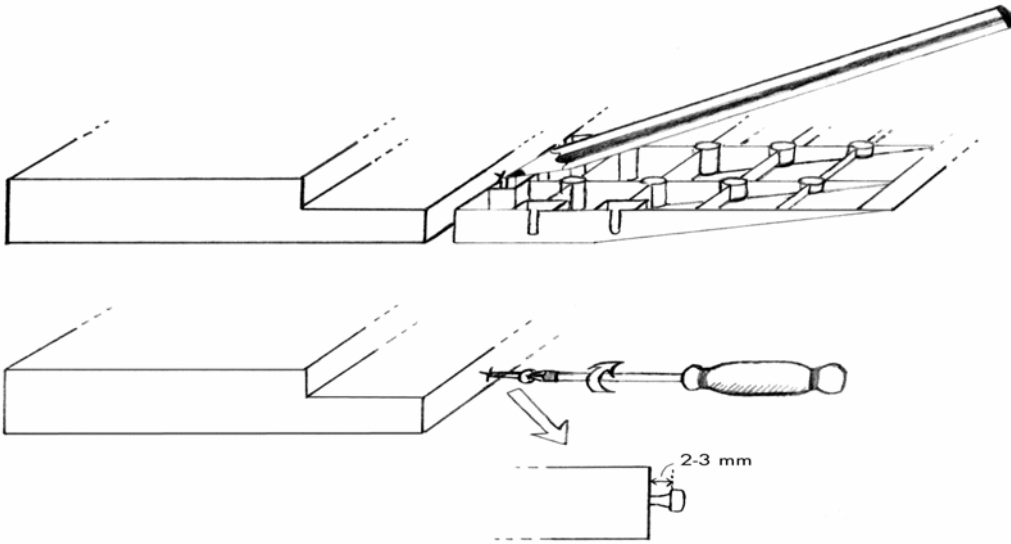

5

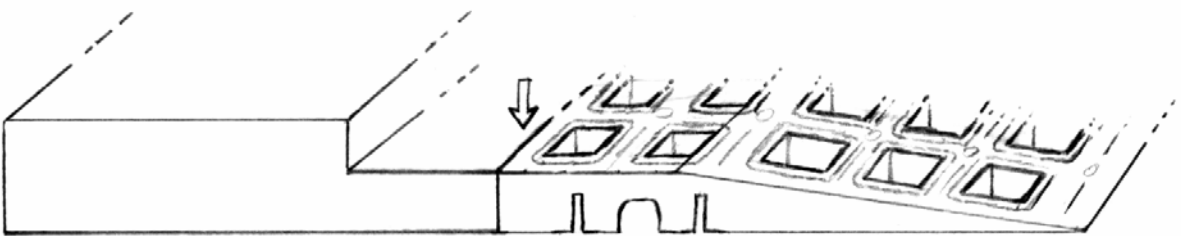

6

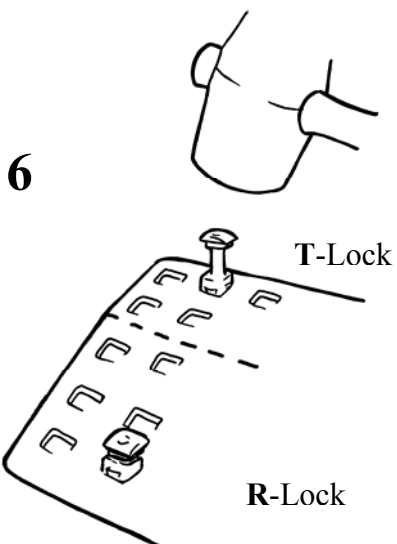

7

